

PikArtMan™

Elegant Marble
Creations

A Journey From Earth to Art

COLLECT
2025
SELECT
ARTS
ARTSIO-02



Asiye Torbati

I am an architect with a Master's degree in Architecture and years of experience in both the design and execution of architectural projects. Currently, I lead a construction company in Turkey, yet my passion for design has always gone far beyond the boundaries of buildings.

Alongside architecture, I've been deeply involved in the visual arts especially painting in abstract and surreal styles. With Pikartman, I bring this artistic spirit into the world of marble.

For me, the true beauty of this work lies in transforming a solid, raw stone into a delicate, functional piece of art. It's about weaving aesthetics into everyday rituals—about turning moments of gathering into moments of meaning.



Hatice Çiyancı Köseoğlu

My journey began as a chemical engineer working on a production line and evolved into the world of natural stone when I founded Pikas Stone in 2011. Over the years, I've built a strong foundation in craftsmanship, innovation, and trust—completing many successful projects and leading a talented, adaptable team along the way.

My passion for natural stone has now inspired a new chapter with Pikartman. I've always been driven to explore fresh possibilities combining design and craftsmanship to offer a broader, more creative perspective to the industry.

With Pikartman, I feel confident we're shaping something meaningful: a new way to see and experience marble in everyday life.

Story of the brand

We are two passionate women from Turkey and Iran whose paths crossed in the most inspiring way. United by our rich cultural roots and years of experience, we came together around a shared dream. Bold and curious, with a deep appreciation for natural materials, we set out to bring fresh creativity into design.

With Pikartman, we've crafted a unique line of elegant marble trays—reimagining stone through a refined, artistic lens. More than functional pieces, these trays embody warmth, friendship, and hospitality. Designed to spark intimate conversations and elevate everyday rituals, they invite people to gather in comfort and style.

By blending tradition with innovation, we offer a collection that honors nature while introducing a fresh, thoughtful approach to décor.

Our story is one of courage, collaboration, and creativity—bringing beauty and connection to every table.

PikArtMan™

Isadora

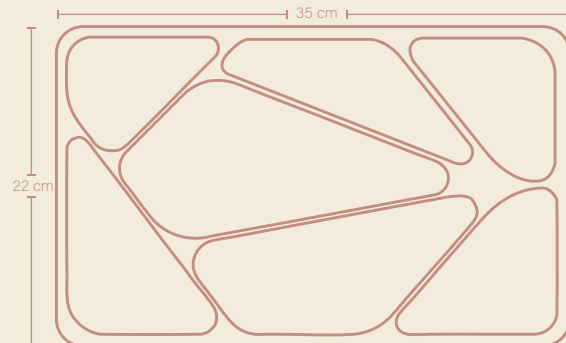

Weight :2200 gr.



Available Colors

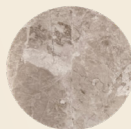

Diana Royal



Silver Gray

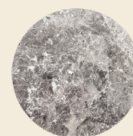

Tundra Gray



Absolute Black

Grace curved
in stone

PikArtMan™

Samuel

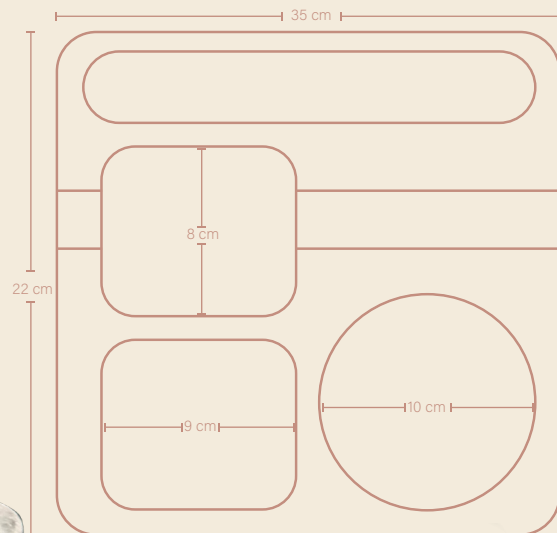

Weight: 1450 gr.



Available Colors



Diana Royal



Silver Gray

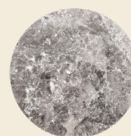

Tundra Gray

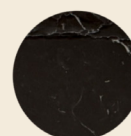

Absolute Black

Crafted for
refined ritual

PikArtMan™

Prisma

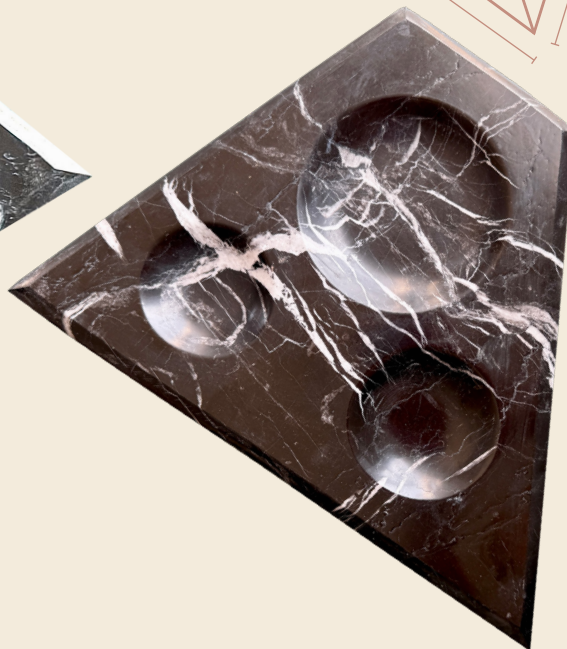
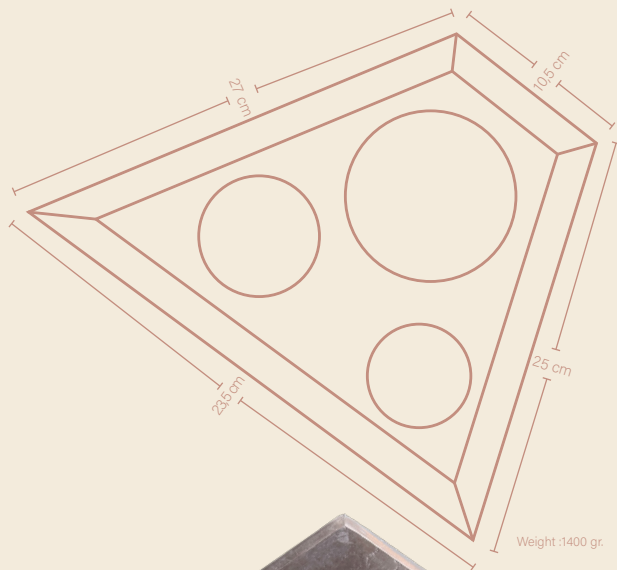

Available Colors

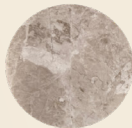

Diana Royal



Silver Gray

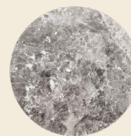

Tundra Gray



Absolute Black

A sculptural
statement
in stone

PikArtMan™

Xenon

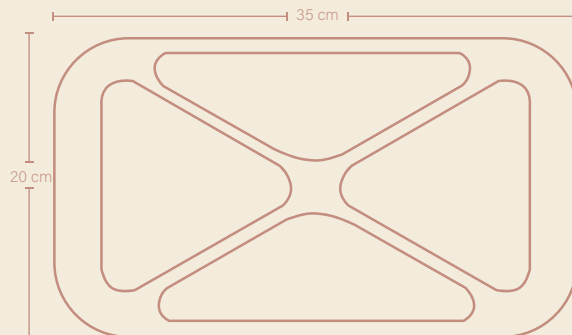

Weight :1450 gr.

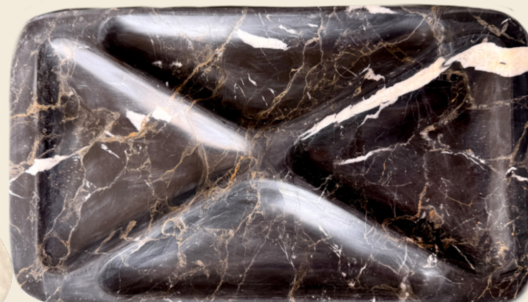

Available Colors

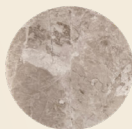

Diana Royal



Silver Gray

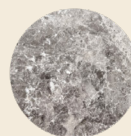

Tundra Gray



Absolute Black

Bold
geometry
pure
elegance

PikArtMan™

Vectora

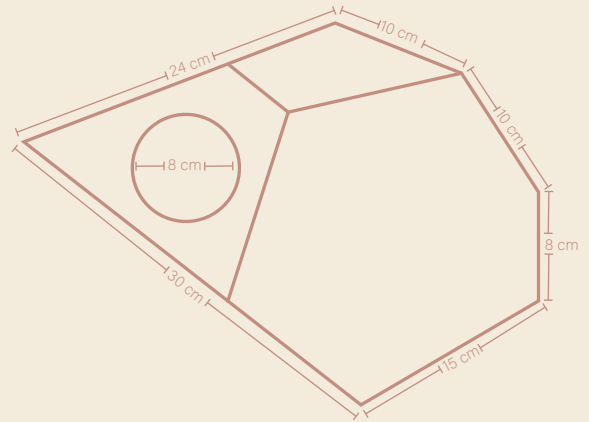

Weight: 1200 gr. + 600 gr. + 400 gr.

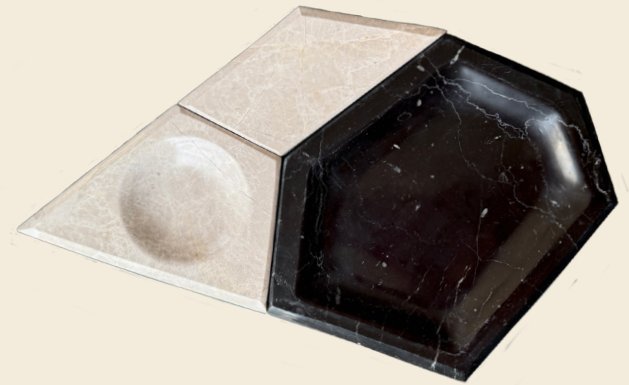

Available Colors



Diana Royal



Silver Gray

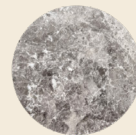

Tundra Gray



Absolute Black

Designed to
connect
Crafted to
flow

PikArtMan™

Atlas

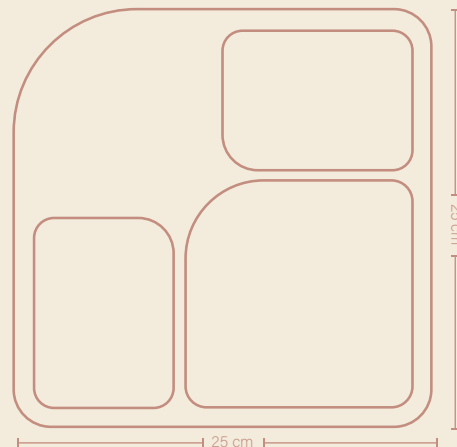

Weight :1800 gr.



Available Colors



Diana Royal



Silver Gray

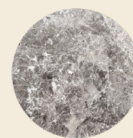

Tundra Gray



Absolute Black

A map of
moments

PikArtMan™

Aura

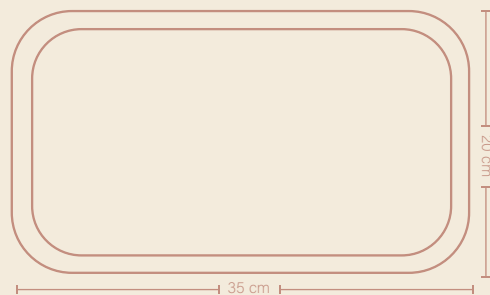

Weight :1500 gr.

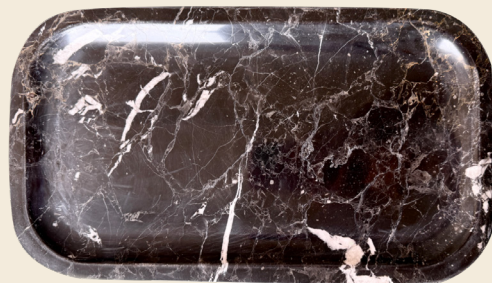

Available Colors

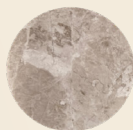

Diana Royal



Silver Gray

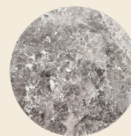

Tundra Gray



Absolute Black

Minimal
presence
lasting
impressions

PikArtMan™

Elera

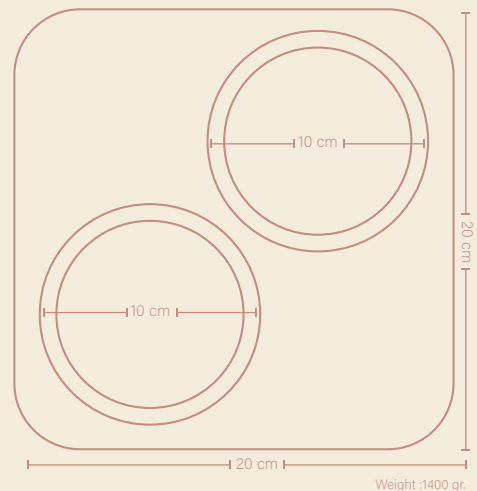

Available Colors

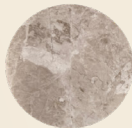

Diana Royal



Silver Gray

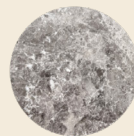

Tundra Gray



Absolute Black

A gentle
pause
in marble

PikArtMan™

Harmonia

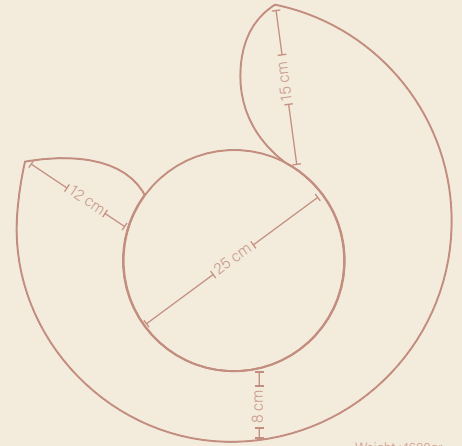

Weight :4600gr.

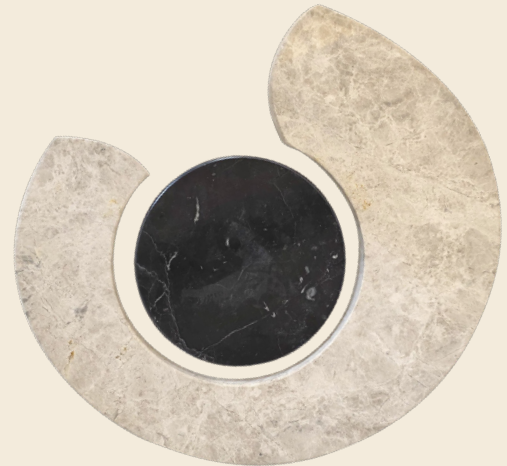

Available Colors

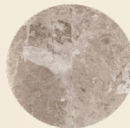

Diana Royal



Silver Gray

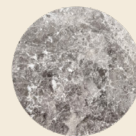

Tundra Gray



Absolute Black

Balance in
contrast,
harmony in
form

PikArtMan™

Thank you

info@pikartman.com

+90 532 713 4138

+90 552 588 9189

[@pikartman.studio/instagram](https://www.instagram.com/pikartman.studio/)